

Data Sheet



Article number: 03493070

Description: Fluro Heavy Duty Rod end EAL 70 EW-2RS
M56x4 Male thread

Note: 70

Measures

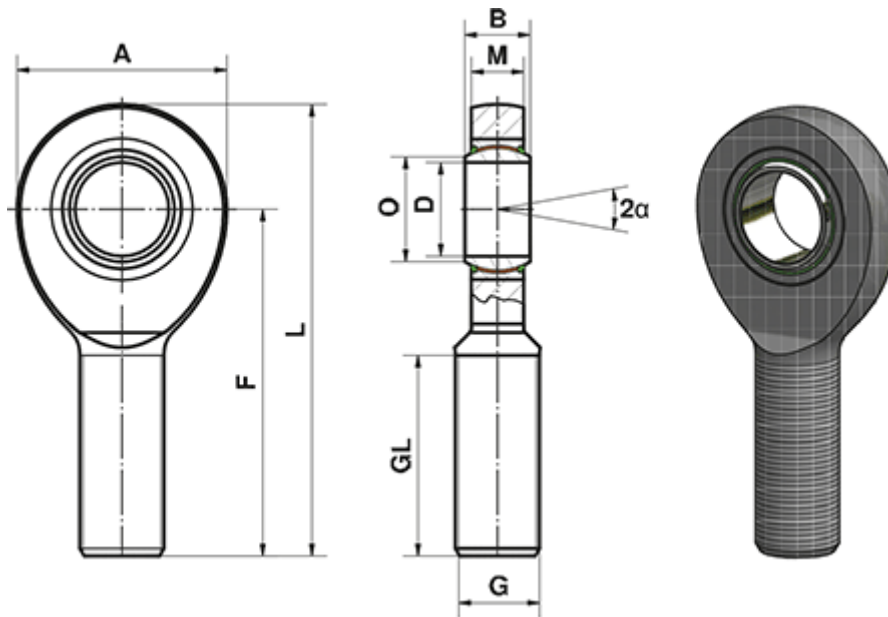

A	= 160	L	= 315
a (degrees)	= 6	M	= 40
B	= 49	O	= 77.8
D	= 70	Static load C0 (kN)	= 566
Dynamic load C (kN)	= 885	Weight (g)	= 8200
F	= 235		
G	= M56x4		
GL	= 125		